

REDWALL Laser Scan Detector

RLS-3060SH



The REDSCAN RLS-3060 is an innovative laser scan detector. That identifies a moving object's size, speed, and distance from the detector. It processes that information with a unique algorithm, resulting in a highly reliable detection system with minimal false alarms. The detector can also be mounted vertically or horizontally according to the application and site conditions.

With 4 dry-contact output connections and 8 outputs via an IP interface allowing for connections to remote video applications.

The REDSCAN RLS-3060SH is an advanced generation laser scan detector. It has both intelligent detection analysis functions and adjustable detection algorithm parameters that increase its range of applications. It provides flexible solutions that streamline video monitoring and will reduce installation costs.

FEATURES

- 30m radius for 190 degrees range
- Vertical and horizontal mounting
- Unique detection algorithm
- Form C master alarm output
- Automatic area setting function
- Environmental disqualification circuit
- Scene selection (Outdoor, Indoor, Indoor Ceiling/Wall protection and Vehicle)
- 4 independently adjustable detection areas and 4 linked outputs for PTZ camera control (on Analog connection)
- 8 independently adjustable detection area and Redwall event codes for Network Recorder and Video Management software (on IP connection)
- Anti-rotation function
- Anti-masking function
- Fog cancellation algorithm (Patent listed)
- Trouble output
- Tamper output
- Built-in heater
- Analog (Dry contact) & IP connection
- Environmental resistance function
- Non detection area adjustment
- Alarm duration function

OPTIONS

RLS-AT Redscan adjustment tool kit
(Including REDSCAN MANAGER Setup software and LAC-1 Laser area checker)

RLS-PB Pole mount bracket
RLS-SB Adjustable angle mounting bracket
AWT-3 Audible walk tester

SPECIFICATIONS

Model	RLS-3060SH	
Detection method	Infrared Laser Scan	
Laser protection class	Class 1	
Coverage	Vertical area	Max. 60 m (Approx. 200 ft.) at 10% reflectivity
	Horizontal area	Radius:30 m (Approx. 100 ft.), Arc:190° at 10% reflectivity
Detection resolution	0.25°	
Communication port	Ethernet ,RJ-45 ,10BASE-T/100BASE-TX	
Protocol	UDP, TCP/IP *Redwall Event Code	
Power input	24 VDC 24 VAC	
Current draw	400mA max. (24 VDC) 600mA max. (24 VAC)	
Heater power input	24 VDC, 24 VAC	
Heater current draw	400mA max. (24 V DC/AC)	
Mounting height	Vertical area	15 m (50ft.) (recommendation)
	Horizontal area	0.7 m (28in.) (recommendation)
Target object selector	S / M / L	
Sensitivity selector	H / M / L	
Camera control output	N.O. 28 VDC, 0.2 A x 4 outputs	
Master alarm output	Form C, 28 VDC, 0.2 A max.	
Trouble output	Form C, 28 VDC, 0.2 A max.	
Tamper output	N.C. 28 VDC, 0.1 A max.	
Environmental disqualification circuit	Form C, 28 VDC, 0.2 A max.	
Alarm period	Approx. 2 sec., Off delay timer	
Operating temperature	-20 to 60 °C (-4 to 140° F)	
Operating temperature with heater	-40 to 60 °C (-40 to 140° F)	
IP rating	IP66	
Dimensions (H x W x D)	334 x 144 x 155 mm (13.2 x 5.7 x 6.1 in.)	
Weight	2.5kg (88 oz.)	

* Specifications and design are subject to change without prior notice.

DETECTION AREAS

Image of horizontal detection area

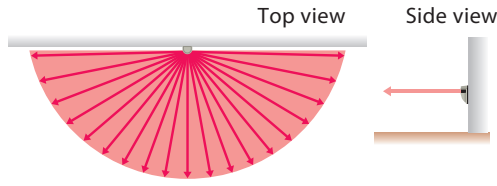
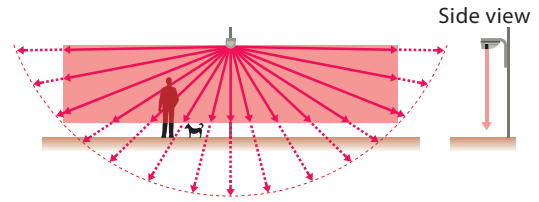
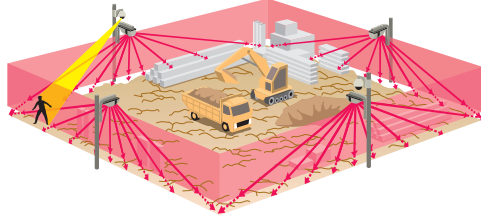

Image of horizontal detection area



Vertical detection area example



Horizontal detection area example

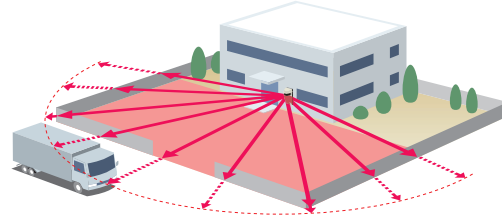

DETECTION AREA PATTERN

4 zones

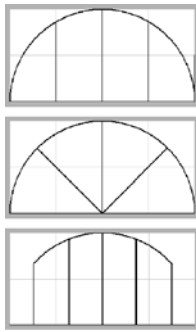

8 zones

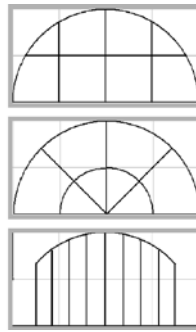

SCENE SELECTION



Indoor, human hand detection

Vehicle detection



DIMENSIONS

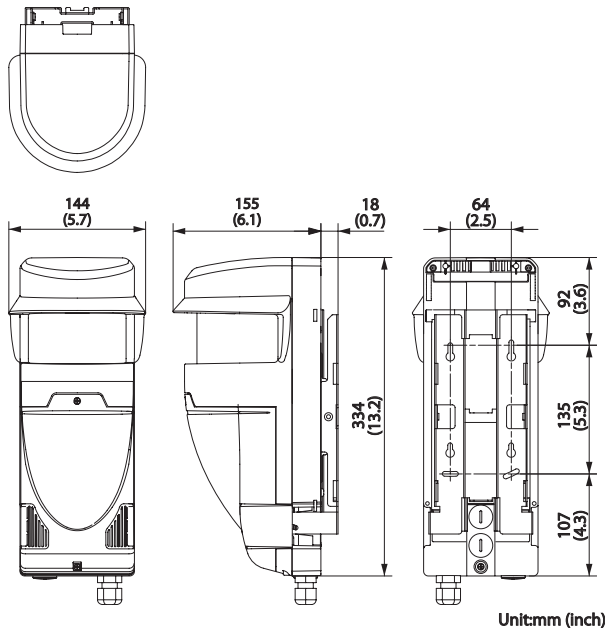

REDCAN MANAGER (Optional software, but needed to set-up)

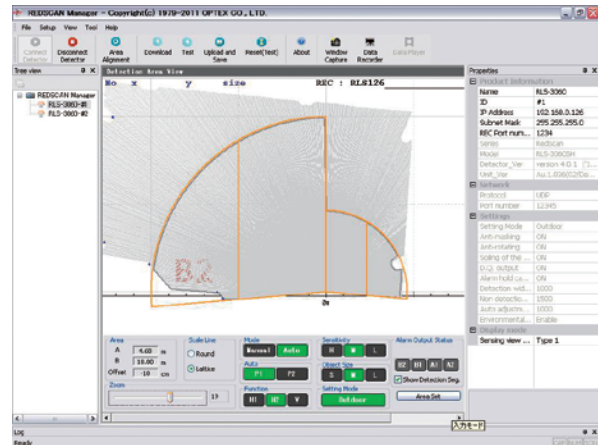

OPTEX CO., LTD.
(JAPAN)
(ISO 9001 Certified)
(ISO 14001 Certified)
5-8-12 Ogoto
Otsu, Shiga, 520-0101
Japan
Tel :+81-77-579-8030
Fax:+81-77-579-7190
URL:http://www.optex.co.jp/e

OPTEX INCORPORATED
(USA)
13661 Benson Ave.
Bldg. C, Chino CA 91710
U.S.A.
Tel :+1-909-993-5770
Fax:+1-909-628-5560
URL:http://www.optexamerica.com

OPTEX (EUROPE) LTD.
(UK)
(ISO 9001 Certified)
Clivemont Road, Maidenhead,
Berkshire, SL6 7BU
UK
Tel :+44-1628-631000
Fax:+44-1628-636311
URL:http://www.optexeurope.com

OPTEX SECURITY SAS
(FRANCE)
475 Rue Monique et Mario Piani
69480 Ambérieux d'Azergues
France
Tel :+33 437 55 50 50
Fax:+33 437 55 50 59
URL:http://www.optex-security.com

OPTEX SECURITY Sp.z o.o.
(POLAND)
ul. Bitwy Warszawskiej 1920 r.
78, 02-366 Warszawa,
Poland
Tel :+48-22-598-06-60
Fax: +48-22-598-06-61